

BatReg²

1.5-kW Bidirectional and Regenerative Digital Battery Cycler and Tester



User's Manual



All Rights Reserved
© CAEN ELS S.r.l.
Rev. 1.0 – January 2025

BATTERY CYCLERS AND TESTERS

This product is  & compliant.



CAEN ELS s.r.l.

Via Karl Ludwig Von Bruck, 32 – 34144 Trieste (TS)
Italy

Mail: info@caenels.com

Web: www.caenels.com

Registered office: via Vetraia 11 – 55049 Viareggio (LU) – Italy





EU DECLARATION OF CONFORMITY

Product:

Laboratory Power Supply
CAEN ELS s.r.l. – BatReg² series
BatReg² 10-150
BatReg² 20-100
BatReg² 40-50
BatReg² 50-30
BatReg² 100-20

Manufacturer:

CAEN ELS s.r.l.
Via Vetràia 11
55049 - Viareggio (LU)
Italy

This declaration of conformity is issued under the sole responsibility of the manufacturer.

Object of the Declaration:

Laboratory Power Supply
Brand: CAEN ELS s.r.l.
Model Family: BatReg²



The object of the declaration described above is in conformity with the relevant Union harmonisation legislation:

2014/30/EU relating to electromagnetic compatibility
2014/35/EU relating to the making available on the market of electrical equipment designed for use within certain voltage limits

References to the relevant harmonised standards used or references to the other technical specifications in relation to which conformity is declared:

EN 61326-1:2013 Electrical equipment for measurement, control and laboratory use - EMC requirements.
EN 61010-1:2010 Safety requirements for electrical equipment for measurement, control, and laboratory use -- Part 1: General requirements.

Signed for and on behalf of: CAEN ELS s.r.l.

Trieste - December 9th, 2024

Enrico Braidotti, CEO



User Manual – Models – Options – Custom Models

This manual covers the following standard Power Supplies models:

Model	Ordering code
BatReg ² 100V-20A	BREG2100020A
BatReg ² 50V-30A	BREG2050030A
BatReg ² 40V-50A	BREG2040050A
BatReg ² 20V-100A	BREG2020100A
BatReg ² 10V-150A	BREG2010150A

This manual covers the following optional accessory:

- **FB1K5OPT0001 – Analog Control, Auxiliary ADC, Trigger Input and Type K IEC thermocouple add-on**

For technical assistance please refer to the following contact:

CAEN ELS s.r.l.
Via Karl Ludwig Von Bruck, 32
34144 Trieste (TS) – Italy

Phone: +39 040 883 0028
e-mail: support@caenels.com

Table Of Contents

1. INTRODUCTION.....	12
1.1 BATREG ² OVERVIEW	12
1.2 BATREG ² AT A GLANCE.....	14
1.3 MODES OF OPERATION.....	16
1.3.1 Regulation Mode.....	16
1.3.2 Control Mode.....	16
1.3.3 Setpoint Mode	17
2. INSTALLATION.....	18
2.1 PREPARATION FOR USE.....	18
2.2 INITIAL INSPECTION	18
2.3 MOUNTING.....	19
2.3.1 Rack Mounting.....	19
2.3.2 Desktop use	19
2.3.3 Recommended Cables Length.....	20
2.4 AC INPUT POWER CONNECTION	20
2.4.1 AC Source requirement.....	23
2.4.2 AC Input Cable	23
2.5 LOAD CONNECTION	23
2.5.1 Wire selection.....	23
2.6 GROUNDING OUTPUTS	25
2.6.1 Functional Ground.....	25
2.7 FIRMWARE UPDADE.....	25
2.7.1 Firmware upgrade from the GUI.....	26
2.8 FIRST POWER-ON	27
3. FRONT/REAR PANEL CONTROLS AND CONNECTORS	29
3.1 EXTERNAL INTERLOCKS AND OUTPUT STATUS.....	29
3.2 REMOTE SENSING	32
3.3 OPTIONAL UNIT FB1K5OPT0001	34
3.3.1 Trigger Input (TRG. IN).....	35
3.3.2 Analog Control Input (AN. IN)	35
3.3.1 Configurable AUX Input (AUX. IN).....	36
3.3.2 Type K IEC thermocouple connector.....	36
3.4 OUTPUT CONNECTORS.....	37
3.4.1 High-Current (HC) Models.....	37
3.4.2 High-Voltage (HV) Models	37
3.5 FRONT PANEL INDICATORS	38
3.6 INTERNAL PROTECTIONS	40
3.6.1 Overtemperature Fault	41
3.6.2 DC-Link Fault.....	41
3.6.3 Input OverCurrent – OVC.....	41
3.6.4 DCCT Error.....	41
3.6.5 OverPower - OVP	41
3.6.6 Output Overcurrent/Overvoltage.....	42
3.6.7 Thermocouple Fault.....	42

3.6.8 Fans Error	43
4. ADVANCED FUNCTIONS	44
4.1 WAVEFORM	44
5. MECHANICAL DIMENSIONS.....	45
6. TECHNICAL SPECIFICATIONS	47



Document Revisions

Revision	Date	Comment
0.0	October 21 th , 2024	Preliminary release.
1.0	January 15 th , 2025	First release.







Safety information

The following table shows the general environmental requirements for a correct operation of the instruments referred to in this User’s Manual:

Environmental Conditions	Requirements
Environment	Indore use
Operating Temperature	0°C to 40°C
Operating Humidity	20% to 80% RH (non-condensing)
Altitude	Up to 2000 m
faultPollution degree	2
Overtoltage Category	II
Storage Temperature	-10°C to 60°C
Storage Humidity	5% to 90% RH (non-condensing)

The following legend summarizes all the symbols adopted in this manual.

-  **CAUTION Risk of Electrical Shock**
-  Caution: Documentation must be consulted in all cases where this symbol is marked
-  Ground terminal
-  Protective Ground Conductor Terminal
- **0** Off (Power)
- **I** On (Power)

WARNING

- The WARNING sign denotes a hazard. An attention to a procedure is called. Not following the procedure correctly could result in personal injury. A WARNING sign should not be skipped and all indicated conditions must be fully understood and met.

CAUTION

- The CAUTION sign denotes a hazard that requires to follow the correct procedure. Failing to do so could result in damage to the equipment. Do not proceed beyond a CAUTION sign until all indicated conditions are fully understood and met.

CAEN ELS S.r.l. will repair or replace any product within the guarantee period if the Guarantor declares that the product is defective due to workmanship or materials and has not been caused by mishandling, negligence on behalf of the User, accident or any abnormal conditions or operations.

Please read carefully the manual before operating any part of the instrument

WARNING

**Do NOT open the BOX TOP
COVER**

CAUTION

Customer shall provide the use of a G99 contactor to cover the ERE G99 requirements for the connection of generation equipment in parallel with public distribution networks

Disposal of the Product

The product must never be dumped in the Municipal Waste. Please check your local regulations for disposal of electronics products.



WARNING

This product is designed for charging batteries, including lithium-based batteries. Improper use or failure to follow the guidelines outlined in this manual can result in serious damage to the battery, leading to incidents such as overheating, fire, or explosion.

This power supply is capable of delivering voltages and currents that may exceed the maximum tolerances of the battery being charged. **It is the operator's sole responsibility to ensure that the battery is operated within its safe operating limits.**

To ensure safe operation:

1. Only use the product with compatible battery types and configurations as specified in this manual.
2. Verify that the charging voltage and current are appropriately set to match the specifications and safe operating range of the battery.
3. Monitor the battery and charging process, and immediately stop operation if any abnormal behavior (e.g., swelling, overheating, or unusual smells) is observed.
4. Do not use damaged, defective, or untested batteries.
5. Ensure proper ventilation during charging to prevent heat buildup.
6. Never leave the product unattended while in operation.
7. Do not use this product in any manner not specified by the manufacturer. The protective features of this

- product may be impaired if it is used in a manner not specified in this manual.
8. Do not use the device if it is damaged. Before using the device, inspect it for possible cracks or breaks before each use.
 9. Do not operate the device around explosive gas, vapor, or dust.
 10. Always use the device with the provided cables.
 11. Turn off the device before establishing any connection.
 12. Do not operate the device with the cover removed or loosened.
 13. Do not install substitute parts or perform any unauthorized modifications to the product.
 14. Return the product to the manufacturer for service and repair to ensure that safety features are maintained.
 15. This is a Class A product. In a domestic environment, this product may cause radio interference, in which case the user may be required to take adequate measures.

Disclaimer:

The manufacturer, CAEN ELS S.r.l., declines all responsibility for damages or injuries resulting from improper use, negligence on the part of the user, non-compliance with instructions, or the use of incompatible batteries. The operator is fully responsible for ensuring the safe operation of the system, adhering to the battery's safety specifications, and thoroughly reading this User's Manual before performing any kind of operation.

CAEN ELS S.r.l. reserves the right to change partially or entirely the contents of this Manual at any time and without giving any notice.

1. Introduction

This chapter describes the general characteristics and main features of the BatReg², the next generation of bidirectional and regenerative Power Supply (PS) series, designed to meet the highest standards for precision battery testing and cycling.

The BatReg² series not only delivers cutting-edge performance in every control mode, but it also safely returns excess energy back to the grid, ensuring maximum efficiency. With individual models reaching up to 100 V and ± 150 A, these units provide the power and reliability required for the most demanding applications.

The BatReg² also features an integrated polarity detection circuit that automatically verifies a correct battery connection, activating output only when safe, guaranteeing a risk-free use.

1.1 BatReg² Overview

High performances, extreme stability, effortless configuration as well as bidirectional and regenerative functionality are the key features of the BatReg² power supply series.

The BatReg² is an independent current- or voltage-controlled digital bidirectional and regenerative power supply module specifically designed for battery testing.

The models, as can be seen in Table 1.1, are set apart by different current and voltage output ratings; the table also indicates the classification between High-Current (HC) and High-Voltage (HV) models.

Model Name	Voltage	Current	HC vs HV
BatReg ² 100-20	0 - 100 V	± 20 A	HV
BatReg ² 50-30	0 - 50 V	± 30 A	HV
BatReg ² 40-50	0 - 40 V	± 50 A	HC
BatReg ² 20-100	0 - 20 V	± 100 A	HC
BatReg ² 10-150	0 - 10 V	± 150 A	HC

Table 1.1: BatReg² standard models.

The BatReg² module is compact and fits in a single 19-inch 2U standard crate. The PS (Power Supply) features a completely digital control loop with a Pulse Width Modulation (PWM) generation technique that allows system adaptation to any load condition.

The control board houses a dedicated FPGA with integrated dual-core ARM CPU. The loop regulation task is performed directly by the FPGA logic, in order to have high performance and deterministic loop control. On the ARM CPU it is installed an embedded Linux OS, that supervises all processes such as communication, diagnostics and local interface handling.

Remote communication is guaranteed by means of an Ethernet 10/100/1000 Mbit autosensing socket, present on the front panel of the PS. The power supply can be also monitored and controlled via a navigation switch and a graphic high-resolution color display featuring user-friendly menus.

In addition to the standard Ethernet interface, it is possible to communicate with the PS using the SFP-ports on the front panel. This interface allows the communication using a proprietary packet structure with an update rate up to 100 kHz. These ports are directly connected to the FPGA logic, so that the packet is elaborated directly by the hardware logic.

This approach bypasses the software stratification that manages the packet. The computational time is shorter and deterministic, leading to a high update rate of the setpoint, and gaining flexibility and excellent rates for the digital control of the power supply.

1.2 BatReg² at a glance

The BatReg² system is composed by a single 19-inch 2U crate. **Figure 1** shows the PS front panel.

Figure 2 and **Figure 3** show the rear panel for the HC and HV models, respectively.



Figure 1: BatReg² front view.

The front side of the BatReg² (**Figure 1**) is equipped with:

1. a power switch;
2. a colour graphic display;
3. a navigation switch for the PS local control;
4. output enable button;
5. three communication sockets (two SFPs and one Ethernet port), 4 status LEDs and one USB device connector.

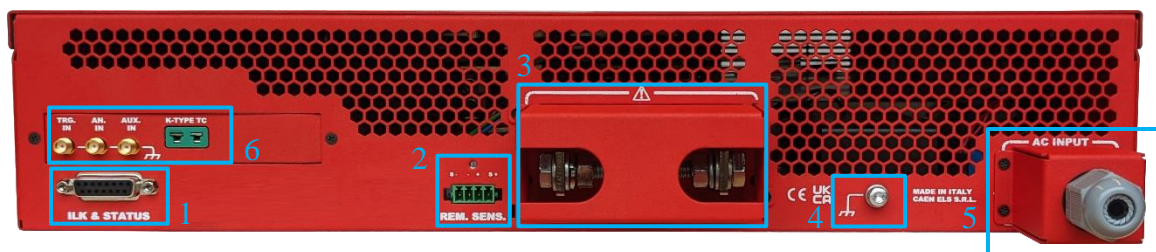

Figure 2: BatReg² rear view for the 150 A, 100 A and 50 A models (“HC” models). N.B. the PS mounts the FB1K5OPT001 option, including the Trigger, Analog Control and Auxiliary inputs, as well as a Type K IEC connector for thermocouples.



Figure 3: BatReg² rear view for the 30 A and 20 A models (“HV” models). N.B. the PS mounts the FB1K5OPT001 option, including the Trigger, Analog Control and Auxiliary inputs, as well as a Type K IEC connector for thermocouples.

The rear side of the PS (**Figure 2** and **Figure 3** for HC and HV models, respectively) is equipped with:

1. D-Sub 15 Female Pin I/O connector for external interlock inputs and status outputs;
2. the remote sensing connector (4-pins connector);
3. the output terminals;
4. an earth reference;
5. the AC power line input;
6. three SMA jack connectors (Trigger, Analog Control, Auxiliary inputs) and Type K IEC connector for external thermocouple for PSs mounting the FB1K5OPT001 option.

1.3 Modes of Operation

The BatReg² system thanks to its multiple features and configurations can be employed in a wide range of applications.

A brief summary of the basic configurations of the are listed below.

1.3.1 Regulation Mode

The BatReg² can be configured as a current-controlled or a voltage-controlled bipolar PSs. The regulation types are:

- **C.C. (Constant Current) regulation** mode: the PS regulates the output current set by the user;
- **C.V. (Constant Voltage) regulation** mode: The PS regulates the output voltage set by the user.

In C.V. mode it is possible to use the *remote sensing* terminals that allow regulating the output voltage directly on the load, thus compensating the voltage drops on the output cables. The BatReg² is capable of compensating a voltage drop up to 0.5 V.

1.3.2 Control Mode

The BatReg² features two control modes

- **LOCAL** control: the PS can be controlled via the front panel color display and the navigation switch. When the PS is set in LOCAL mode, all the remote setting commands are denied. However, it is possible to perform readings and monitor the status of the PS from the remote interface;
- **REMOTE** control: the PS is controlled via the TCP-IP Ethernet interface. The setting and control of the PS can be performed exclusively via this interface, while monitoring is possible from the local display as well;

A detailed description of the LOCAL and REMOTE controls can be found in the “Quick Start Guide”.

1.3.3 Setpoint Mode

The current or voltage setting of the PS can be performed in three different setpoint modes:

- **NORMAL**: the update of the set-point (current or voltage) is performed as soon as a new set-point is received via remote control, local control or fast interface;
- **WAVEFORM**: the update of the set-point is performed on a specific timing (defined as a “waveform” attribute, more information on the *Waveform* section) and it is done internally;
- **ANALOG INPUT**: the PS is controlled by an external analog signal that is fed to the rear BNC connector. The PS acts as a C.C. or C.V. generator depending on the Regulation Mode. Please note that this setpoint mode can be configured only if the analog input SMA connector (FB1K5OPT0001 ordering option at the time of purchase) is installed.

More information about the different setpoint operation modes can be found in the “Quick Start Guide”.

2. Installation

This chapter contains instructions for initial inspection and preparation for use.

2.1 Preparation for use

In order to be operational, the PS must be connected to an appropriate AC source. The AC source voltage should be within the PS specification. Do not apply power before reading sections 2.2 and 0.

The installation procedure is described in **Table 2.1**.

Step	Checklist	Description
1	Initial inspection	Physical inspection of PS
2	Mounting	Installing the PS, ensuring proper ventilation
3	AC Input Power Connection	Connect the PS to the AC source
4	Load connection	Wire size selection, Remote Sensing
5	Grounding Outputs	Check ground connections
6	First power-on	Power-on checkout procedure

Table 2.1: Installation checklist

2.2 Initial inspection

Prior to shipment, the PS was inspected and free of mechanical and electrical defects. Upon unboxing an inspection of the PS is suggested to identify any damage which may have occurred during transit.

The inspection should confirm that there is no-exterior damage to the PS (e.g. broken switch or connectors, scratched panels/display and/or cracked display). Keep all packaging material until the inspection has been completed. If a damage has been detected, compile the RMA form available on the CAEN ELS web site.

2.3 Mounting

The BatReg² module can be used either as a rack-mounted device (since the PS form factor is designed to be installed in a standard 2U 19-inch cabinet) or as a desktop unit.

CAUTION

This PS is fan cooled, the air intake is at the front panel and the exhaust is at the rear panel. Allow cooling air to reach the front panel ventilation inlets, ensuring at least 10 cm of unrestricted air space at the front and the rear of the unit.

2.3.1 Rack Mounting

The BatReg² series is designed to fit in a standard 19” equipment rack.

CAUTION

Use a support bar to provide adequate support for the PS.

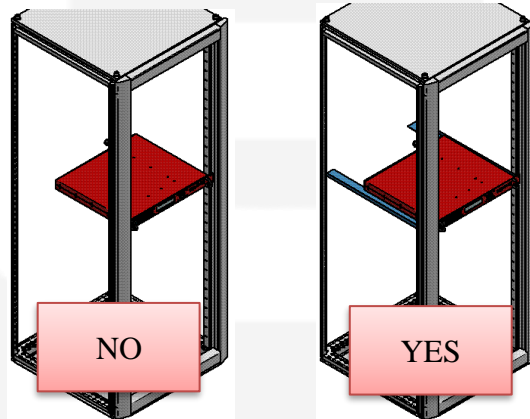

2.3.2 Desktop use

During desktop use all precautions must be taken to avoid touching the output connectors.

WARNING

Users shall protect output contacts either by placing the BatReg² inside a closed rack or by restricting the access to the back side of the PS.

2.3.3 Recommended Cables Length

The recommended length for cables is listed in **Table 2.2**.

Connector	Length
DC Ooutput	< 30 m
AC Input	< 30 m
Interlock & Status (ILK & STATUS)	< 3 m
Crowbar Enable (CROW. EN)	< 3 m
Persistent Current Switch (PCS)	< 3 m
Remote Sensing (REM. SENS.)	< 3 m
*Trigger Input (TRG. IN)	< 3 m
*Analog Input (AN. IN)	< 3 m
*Auxiliary Input (AUX. IN)	< 3 m
*Thermocouple (K-TYPE TC)	< 3 m

Table 2.2: Recommended length for the cables. *These connectors are available only with the ordering option FB1K5OPT0001.

2.4 AC Input Power Connection

WARNING

There is a potential electrical shock hazard when using a PS without protection. Do not connect the PS to an AC supply line without input protection properly installed.

WARNING

PS connection to an AC mains line shall be executed by an electrician or other qualified personnel.

WARNING

There is a potential shock hazard if the PS chassis (with cover in place) is not connected to an electrical safety ground via the safety ground terminal in the AC input connector.

CAUTION

Customer shall provide the use of a G99 contactor to cover the ERE G99 requirements for the connection of generation equipment in parallel with public distribution networks.

CAUTION

AC Input Wires No Conductor Pretreatment: all kinds of copper conductors can be clamped without pretreatment (Solid, Flexible, with ferrule, with/without plastic sleeve). It is strictly forbidden to solder the conductors. The solder tin yields and fractures under high pressure, resulting in an increased contact resistance and an excessive temperature rise. In addition, corrosion caused by pickling or fluxes has been observed on soldered conductor ends. Notch fractures at the transition point from the rigid to the flexible conductor area are also possible.

CAUTION

The PS ON/OFF switch is not the main "power disconnect device" and does not completely disconnect all the circuits from the AC mains. An appropriately rated "power disconnect device" such as circuit breaker, industrial plug complying with IEC 60309 or with a comparable national standard, etc., shall be installed. The "disconnect device" shall disconnect all supply lines simultaneously. The "disconnect device" must be easily accessible.

The connection of this PS to an AC power source should be made by an electrician or other qualified personnel. The PS shall be connected to the AC source via protective device (circuit breaker, fuses, etc.) rated at 20 A max.

The AC line input connector on the rear panel consists in a 7.62 mm terminal block plug from Wurth-Elektronik (P/N: 691340400003) capable of housing cables with 0.2-3.3 mm² of diameter (tightening torque required 0.56 [N·m]).

AC input cord is not provided with the PS. Refer to section 2.4.2 for recommended cables and to **Figure 4**, **Figure 5**, **Figure 6** and **Figure 7** for a correct and safe installation of the AC input cable.

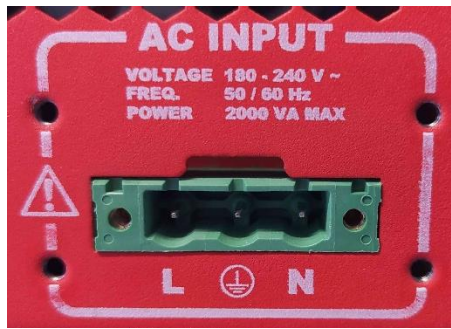

Figure 4: AC Power Line input without terminal block.



Figure 5: AC Power Line input with terminal block.

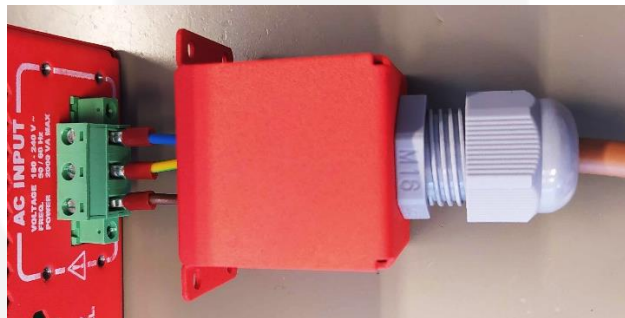

Figure 6: AC Power Line input with connector and cover unmounted.



Figure 7: AC Power Line input with cover mounted.

2.4.1 AC Source requirement

The BatReg² power supplies are designed for an AC input ranging from 180 V to 264 V and input frequency ranging from 47 Hz to 63 Hz. Installation Category must be **CAT II**; maximum impulse voltage on the network mains below 2500 V is mandatory.

2.4.2 AC Input Cable

AC input cables are not provided with the PS. **The AC input cables must satisfy the characteristics reported in Table 2.3.**

AC Input Cable

- 3x 1.5 mm² (2 m maximum length) or 3x 2.5 mm² (length > 2 m);
- 2 wire and a safety ground, stranded copper, 300 V, 105 °C minimum, rated for 20 A;
- Outer diameter: 6-13 mm.

Table 2.3: AC input cables characteristics.

2.5 Load connection

WARNING

Turn off the AC input power before making or changing any rear panel connection. Ensure that all connections are securely tightened before applying power. There is a potential shock hazard when using a PS with a rated output greater than 50 V

2.5.1 Wire selection

Different factors must be considered for wire selection:

- Current carrying capacity (i.e. cross section area)
- Maximum wire length
- Insulation voltage

Wire cross section and length

Wire size should be selected to enable voltage drop per lead to be less than 1 V (over the total cable length) at the maximum PS current to prevent excessive output power consumption. Suggested wire sizes are listed in the following table:

Wire Cross Section Area [mm ²]	Resistivity [Ω/km]	Maximum Cable length in meters to limit voltage drop to be less than 2 V (1 V per lead)				
		20 A	30 A	50 A	100 A	150 A
2.5	8.00	6	-	-	-	-
4	5.00	10	6.5	-	-	-
6	3.33	15	10	-	-	-
10	2.00	25	16.5	10	-	-
16	1.30	40	26.5	16	8	-
25	0.80	62.5	41.5	25	12.5	-
35	0.57	87.5	58	35	17.5	11.5

Table 2.4: Wire selection

If **Table 2.4** values are used the maximum voltage to the load will be limited to:

$$OV_{nom} + CV_{max} - DV_{cable}$$

where **OV_{nom}** is the PS nominal output voltage, **CV_{max}** is the maximum compensation voltage when remote sensing is used and **DV_{cable}** is the cable drop voltage.

Maximum compensation Voltage for all models is 0.5 V

For instance, the BatReg² 100-20, with a nominal output voltage of 20 V, connected to a load at 8 meter of distance using 2x16 mm² cables, can drive maximally 20 + 0.5 - 2 = **18.5 V** at 100 A on the load.

BatReg² HC model (with nominal output voltage < 50 V)

For those models the load has to be connected directly to the Busbars using lug terminals for M8 screws. Always use spring washer and plane washer for a reliable connection. Tightening torque shall be about 15 – 25 N·m.

More details on the output connector are reported in section 3.4.1.

BatReg² HV models (with nominal output voltage ≥ 50 V)

For those models that have output voltage ≥ 50 V shall be connected to the load with a double insulation cable which have voltage rating adequate to the maximum output voltage.

More details on the output connector are reported in section 3.4.2.



Hazardous voltage is present at both the outputs and the load connections. To protect personnel against accidental contact with hazardous voltage, ensure that the load and its connections have no exposed live parts. Ensure that the load wiring insulation rating is greater than or equal to the maximum output voltage of the PS.

2.6 Grounding Outputs

The BatReg² Output Terminals are Floating by design, meaning that either the positive or negative output terminals can be grounded. Always use two wires to connect the load to the PS regardless of how the system is grounded.

WARNING

Models shall not float outputs more than ± 200 VDC above/below chassis ground.

2.6.1 Functional Ground

Figure 8 shows the Functional Ground connection. **The maximum penetration depth (“L” in Figure 9) of the ground mounting screw is 8 mm.**



Figure 8: Functional Ground Connection.

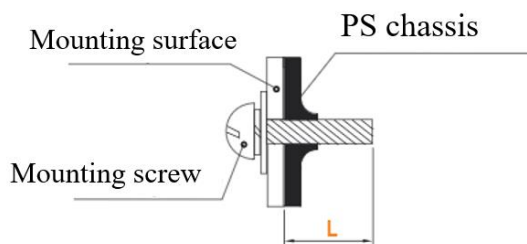

Figure 9: Ground screw picture.

2.7 Firmware Update

Updates of the PS’s firmware can be executed following two procedures:

- from the GUI;
- from the *Device Manager* (refer to the *Device Manager User’s Manual*).

The latest stable firmware can be downloaded from CAEN ELS website from the correspondent product page in the “*Software/Firmware*” section, as reported in Figure 10.

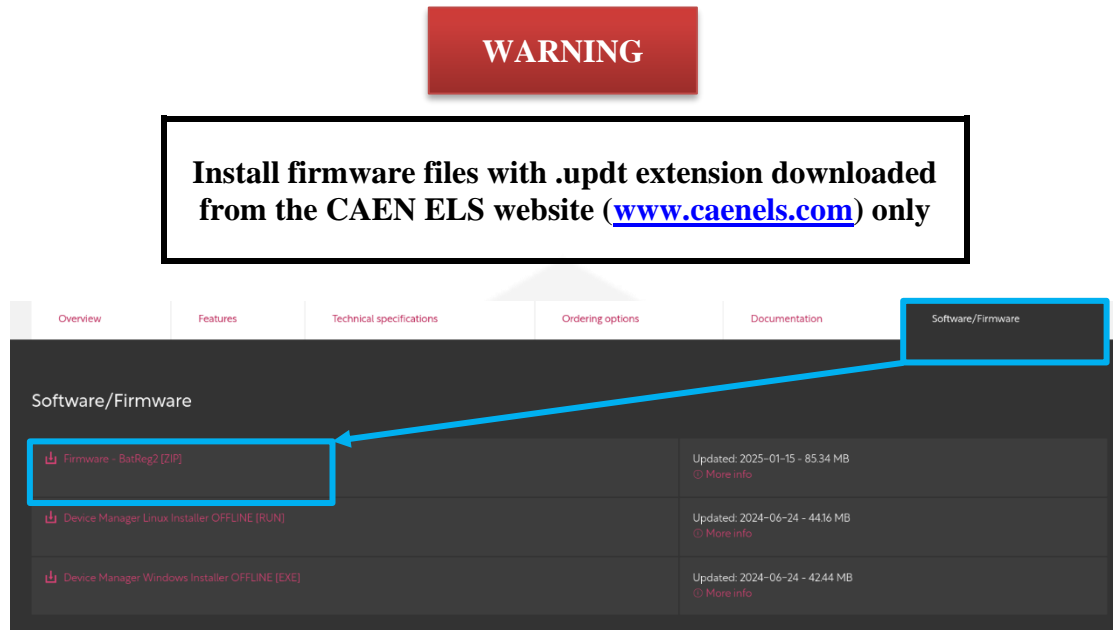

Figure 10: Firmware download page.

2.7.1 Firmware upgrade from the GUI

Type the PS’s IP address in the web browser address bar to access the GUI and click the Update page from the right panel of the GUI, as reported in Figure 11.

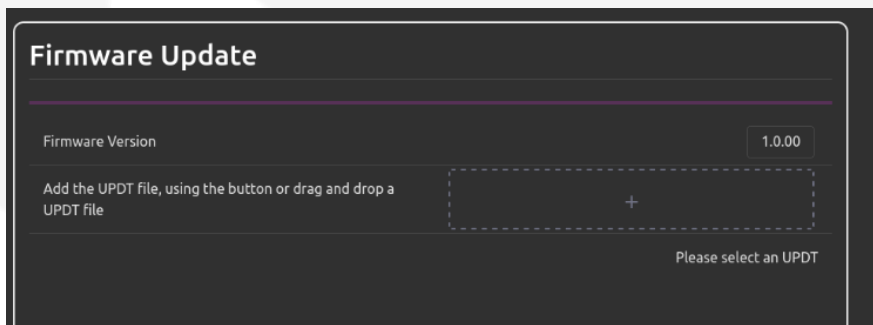

Figure 11: Firmware Update page.

Load the firmware file, previously downloaded from the CAEN ELS website, and click on *Install* button, as shown in Figure 12.

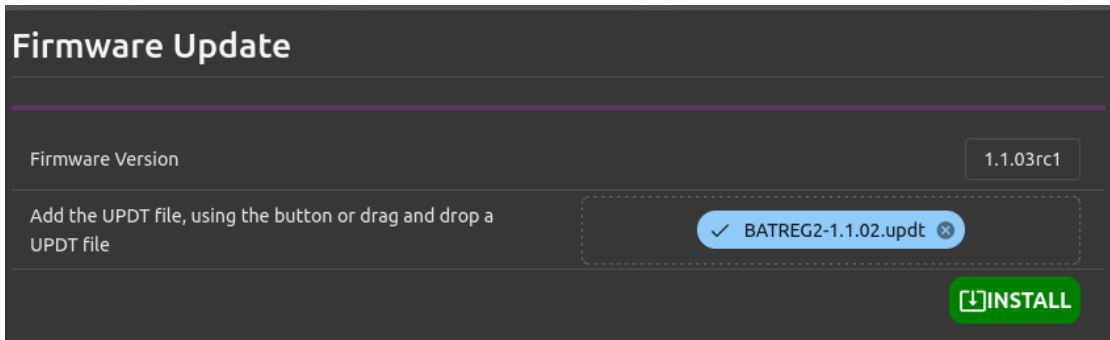

Figure 12: Upload firmware file.

The firmware update procedure can take up to 5 minutes to complete.

At the end of the update procedure the PS is automatically rebooted and once the reboot is completed the webpage should automatically refresh. Otherwise, refresh manually the webpage.

2.8 First Power-on

The BatReg² is equipped with an internal voltage sensing circuit which can sense the output voltage while the output is disconnected in order to detect a battery connected with a reversed polarity. In fact, when a battery is connected with the wrong polarity (see the negative voltage reading in Figure 13) it is not possible to enable the BatReg² output. If this operation is performed by the GUI the PS will respond with a “NAK” (Not Acknowledge) message (see Figure 14a) while if the Local Control is used (by pressing the *Output Enable* button) an error message is shown on the Local Display (see Figure 14b).

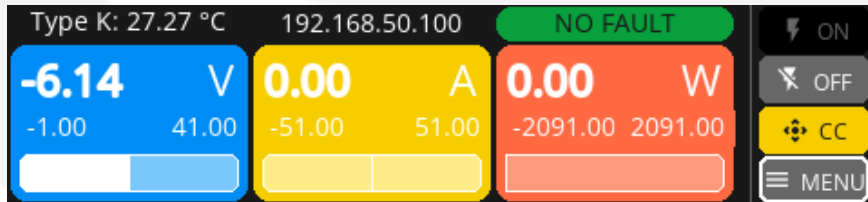

Figure 13: Local Display showing a battery connected with wrong polarity.

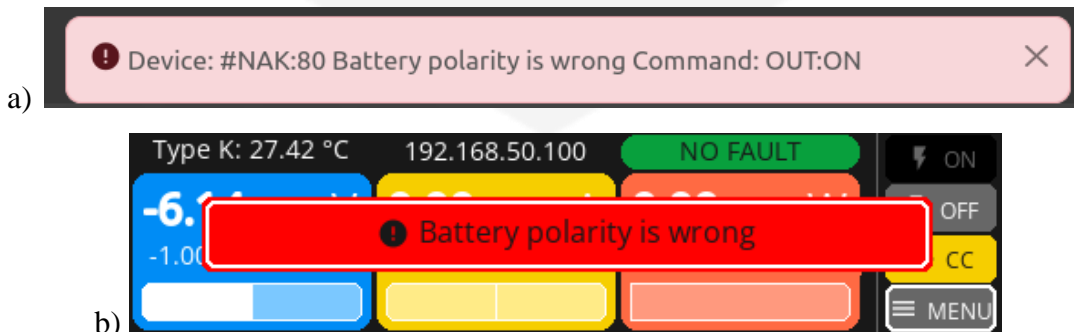

Figure 14: a) NAK response from the GUI. b) Local Display showing wrong polarity error message.

Once the battery is connected with the correct polarity it will be possible to enable the BatReg² output (see Figure 19). When the output is enabled (ON) by the User, the BatReg² raises the output voltage of the power stage to match the battery voltage and

only after that it actually closes the output relay making contact between the BatReg² and the battery. This is very important to avoid sparks that could damage both battery and BatReg².

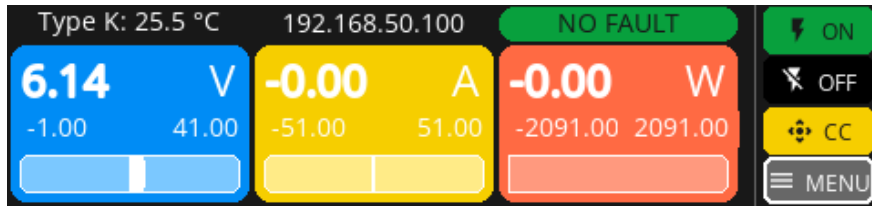

Figure 15: Local Display showing a battery connected with correct polarity, BatReg² output is ON.



3. Front/Rear Panel Controls and Connectors

3.1 External Interlocks and Output Status

The system provides four external interlock inputs that can be easily configured using the GUI or directly using the remote PS commands (refer to the “*Commands Reference Manual*” for more information). Two output status signals, a Magnetic Relay and Solid-State Relay, provide the output status of the power module. There are two kinds of Magnetic Relay:

- Normally Open (NO): when the PS output is OFF the Magnetic Relay is in open-circuit, viceversa when the PS output is ON the Magnetic Relay is in short-circuit.
- Normally Closed (NC): when the PS output is OFF the Magnetic Relay is in short-circuit, viceversa when the PS output is ON the Magnetic Relay is in open-circuit.

The Solid-State Relay behaves like a Normally Open Relay.

External Interlock and Output Status signals are available on a D-Sub 15 Pin Male type on the rear panel of the BatReg², **Figure 16**.



Figure 16: I/O Connector

The pins and their functionality are listed in **Table 3.1**.

Pin Number	Pin Function
1	Ext. Int #1 -
9	Ext. Int #1 +
2	Ext. Int #2 -
10	Ext. Int #2 +
3	Ext. Int #3 -
11	Ext. Int #3 +
4	Ext. Int #4 -
12	Ext. Int #4 +
5	Not Connected
13	Mag. Relay Central Node
6	Not Connected
14	Mag. Relay - NC
7	Solid State Relay 1
15	Mag. Relay - NO
8	Solid State Relay 2

Table 3.1: Corresponding Pin Function on Rear DB15 connector.

The absolute maximum current that can be sunk by the relays are shown in the following table:

Relay	Pins	Max Current	Max Voltage
Magnetic	#13-14-15	1 A	48 V
Solid state	# 7-8	400 mA	48 V

Table 3.2: Ratings of relays

WARNING

Magnetic Relay Contact and Solid State Relay Terminals (Terminal #1 & #2) shall not float more than ±60 VDC above/below chassis ground.
Interlocks input and return pins shall not float more than ±60 VDC above/below chassis ground.



CAUTION

Voltage between relay pins shall never exceed ± 48 V.
 Maximum current rating for the Magnetic Relay is 1 A.
 Current trough pins #13 and #14 or pins #13 and #15 shall never exceed 1 A.
 Maximum current rating for the Solid-State Relay is 400 mA.
 Current trough pins #7 and #8 shall never exceed 400 mA.
 Input interlocks are **Dry-Contact**: do not apply voltage between any input interlock and its corresponding return.

The interlock pins are galvanically isolated from ground and outputs terminals, nevertheless the absolute maximum voltage, referred to ground, that pins can continuously sustain is 48V. The four interlock inputs have their own return connection; when the input pin and its corresponding return pin are shorted the interlock is hardware-activated. Interlock schematic diagram is here after presented:

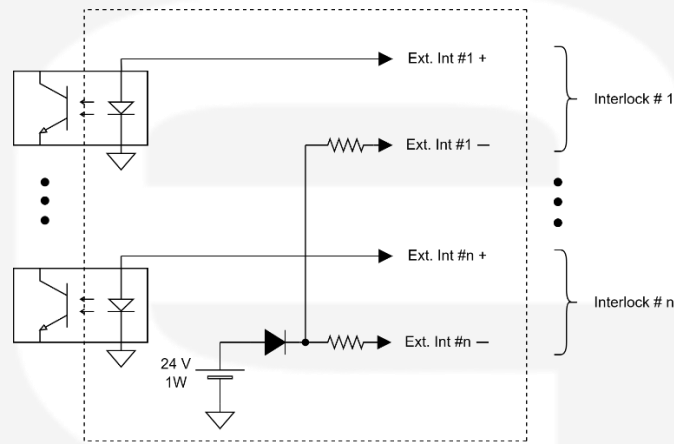

Figure 17: Interlock Dry-Contact input scheme

Interlocks can be easily configured from the Web-server or from the Internal Memory (Internal Memory addresses are reported in **Table 3.3**).

ID	Name
140	Interlock Enable Mask
141	Interlock Activation Level Mask
144	Interlock #1 Intervention Time [ms]
145	Interlock #1 Name
146	Interlock #2 Intervention Time [ms]
147	Interlock #2 Name
148	Interlock #3 Intervention Time [ms]

ID	Name
149	Interlock #3 Name
150	Interlock #4 Intervention Time [ms]
151	Interlock #4 Name

Table 3.3: Interlock settings parameters in Internal Memory.

For more information about interlocks configuration refer to the “*Commands Reference Manual*” and to the “*Quick Start Guide*”.

3.2 Remote Sensing

WARNING

There is a potential risk of electric shock at the sensing point when using a power supply with a rated output voltage exceeding 50 V. To ensure safety, make sure the connections at the load end are properly insulated to prevent accidental contact with hazardous voltages.

CAUTION

A short between V_{SENS+} or V_{OUT+} to V_{SENS-} or V_{OUT-} will damage the PS. Reversing the sense wire might damage the PS in both local and remote sensing. Do not connect +S to – or –S to +.

The Remote Sensing Connector (located on the rear panel) is reported in **Figure 18** (left picture) and its pinout is reported in **Table 3.4**. The PS is shipped with the remote sensing terminal block (see **Figure 18** right picture) from Wurth-Elektronik (P/N: 691304330004).

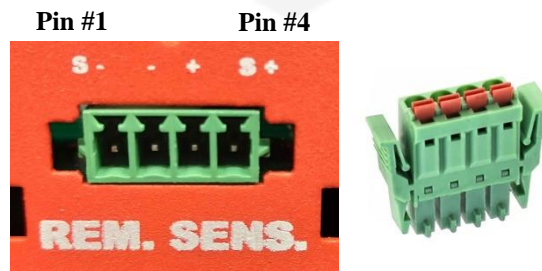

Figure 18: Remote Sensing connector on the PS’s rear panel (left picture). Remote Sensing terminal block (right picture)

Description	Pin	Name
V _{SENSE -}	#1	S-
V _{OUT -}	#2	-
V _{OUT +}	#3	+
V _{SENSE +}	#4	S+

Table 3.4: Remote sensing pinout.

By using the two “sensing” pins (S+ and S-, pins 4 and 1, respectively), it is possible to perform output voltage sensing directly on the load, thus excluding from the measurements potential voltage drops of the output cables (up to 0.5 V).

To limit the pick-up noise, when using the remote sensing feature, the use of twisted cables is highly recommended.

The BatReg² is shipped with a mating connector (Wurth Elektronik P/N: 691304330004) for remote sensing that short-circuits the S+ and + pins and the S- and - pins, respectively (see **Figure 19**). This configuration performs remote sensing directly at the output connector of the PS. When using the remote sensing feature, leave pins #2 (+) and #3 (-) disconnected.



Figure 19: Factory mating Remote Sensing connector.

Follow the instructions below to configure the PS for remote sensing:

1. Ensure that the Mains switch is on Off position “O”
2. Remove factory jumpers between +S to + and -S to -.
3. Using a twisted pair or shielded cable (suggested wire size is 0.3 or 0.5 mm²) connect the +S terminal to the positive output terminal and the -S to the negative output terminal as illustrated in **Figure 21**.
4. **For BatReg² with output voltage rating > 50 V**, secure the safety cover to the rear panel using the M3x10 mm screw, **Figure 20**.



Figure 20: Remote Sensing Cover

In order to perform remote sensing at different points – e.g. the load terminals – connect Pin #1 and Pin #4 as in **Figure 21**:

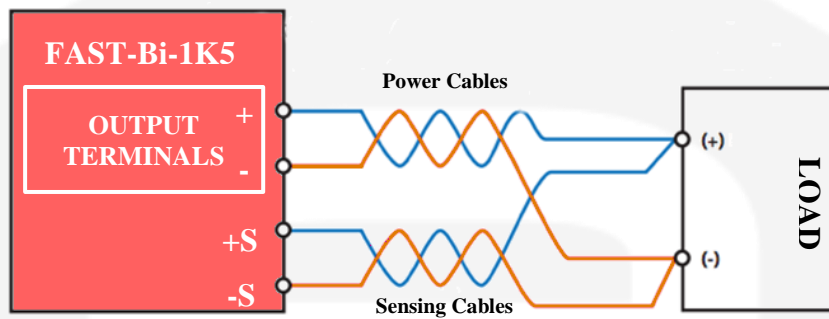

Figure 21: Example of Remote Sensing

3.3 Optional Unit FB1K5OPT0001

The additional option FB1K5OPT0001 includes the following input connectors (see **Figure 22**):

- TRG. IN (SMA jack) external Trigger signal;
- AN. IN (SMA jack) Analog control;
- AUX. IN (SMA jack) additional conversion (ADC) auxiliary channel;
- K-TYPE TC (Type K IEC) thermocouple.

An input connector for Type K thermocouple is also present.

CAUTION

The SMA connectors are not floating but referred to the Chassis' Earth.



Figure 22: SMA jack input connectors and Type K IEC for thermocouple.

A brief description of these features and their functionalities is presented below.

3.3.1 Trigger Input (TRG. IN)

The Trigger Input (TRG. IN) accepts TTL (5V) and LVTTL (3.3V) compatible signals. It should be driven by a low-impedance source to ensure proper operation.

The trigger input incorporates hysteresis, which means the logic levels are designed to avoid instability around the switching thresholds. The recognized voltage levels that guarantee correct operation of the trigger are detailed in **Table 3.5**.

Logic Level	Value
Low-to-HIGH	> 2.0 V
High-to-LOW	< 0.8 V

Table 3.5: Trigger Logic Levels for trigger input.

CAUTION

The absolute maximum rating for the Trigger Input signal is **5.5 V** (a higher voltage level applied to this input can seriously damage the device).

3.3.2 Analog Control Input (AN. IN)

The Analog Control Input (AN. IN) allows the PS to be controlled as an “amplifier”; the PS generates an output which is proportional to the analog control input signal.

This Analog Control Input accepts signals ranging from -10V to +10V, corresponding to –Full-Scale to +Full-Scale of the PS output rating (it can be either current or voltage, depending on the Regulation Mode selected). An example of the relation between the analog input signal and the PS output is shown in **Figure 23**.

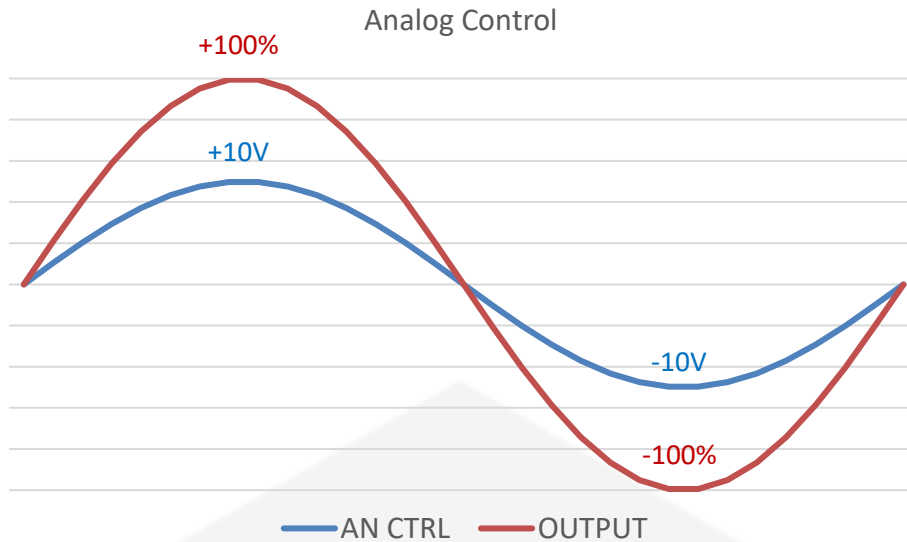

Figure 23: ANALOG CONTRL vs OUTPUT dependence

Please note that the analog control input bandwidth is internally limited to 1 kHz.

3.3.1 Configurable AUX Input (AUX. IN)

The Auxiliary Input (AUX. IN) connector provides monitoring capabilities of an external signal source such as temperature sensors and field probes (Hall sensor). The Auxiliary Input accepts signals ranging from -10V to +10V and the conversion value, identified by a scale-factor, can be stored in the PS.

Example: for a temperature sensor having a 20 mV/°C gain, the input scale-factor needs to be configured taking into account that the equivalent temperature at a potential ADC full-scale of 5 V would be the following:

$$T_{FULL-SCALE} = \frac{5 \text{ V}}{20 \text{ mV}/^{\circ}\text{C}} = 250 \text{ }^{\circ}\text{C}$$

Having the ADC a 16-bit resolution, the LSB value, equivalent to the scale-factor that needs to be saved to the PS for a correct reading is:

$$K_{LSB} = \frac{T_{FULL-SCALE}}{2^{16} - 1} \cong 0.0038 \text{ }^{\circ}\text{C}$$

3.3.2 Type K IEC thermocouple connector

The FB1K5OPT0001 option offers the possibility of connecting a K-type thermocouple. The board mounts a MAX31856MUD+ IC that digitizes the thermocouple signal via SPI-interface.

3.4 Output connectors

The load must be connected to the output connector placed on the PS rear panel. Two types of connectors are provided depending on the maximum output voltage rating of the PS.

3.4.1 High-Current (HC) Models

For High-Current models (HC, see **Table 1.1**), busbars terminals are present on the rear panel, see **Figure 24(a)**, providing a convenient and reliable way of connecting the load. **Figure 24(b)** shows the output terminals with the protecting cover, while **Figure 25** shows a proper connection with the load cables (refer to section 2.5 for screws and cables characteristics).

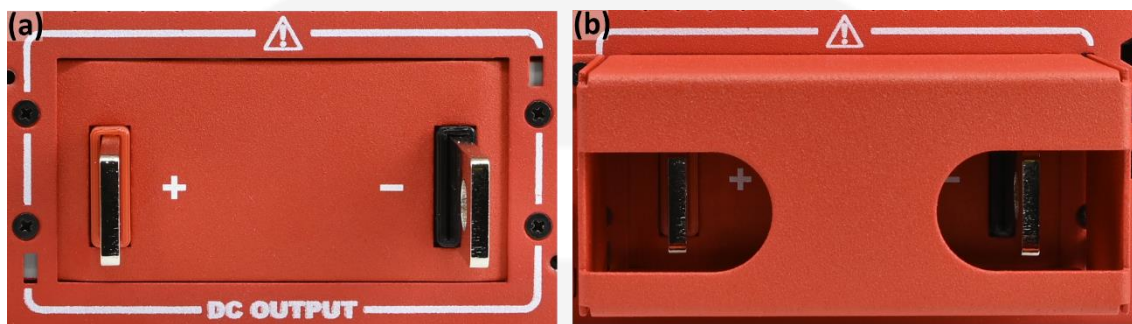

Figure 24: Output terminals for High Current models without (a) and with (b) cover, respectively.



Figure 25: Output terminals for High-Current models with cover and isolated load cables connected.

WARNING

Only adequate isolated cables should exit the cover.

3.4.2 High-Voltage (HV) Models

For High-Voltage models (HV, see **Table 1.1**) a PCB terminal block (PHOENIX CONTACT P/N: 1735781) is provided on the rear panel, see **Figure 26**, suitable for cables with a cross section from 0.75 mm² up to 10 mm². The terminal part

of the cable has to be stripped and equipped with a 18 mm long ferrule (as seen in **Figure 27**, ferrule on blue cable). Symbols “+” and “-” indicate the positive and negative polarity of the terminal, respectively.

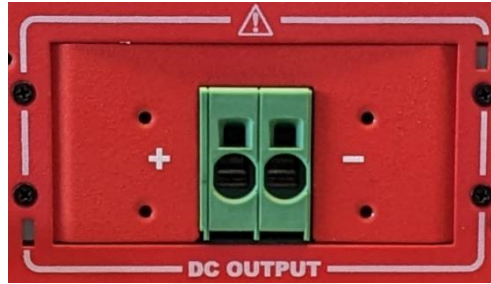

Figure 26: Output Connector for High-Voltage models, without cover.

The push-in mechanism ensures an easy and a long-term stable load connection. Indeed, for the connection it is sufficient to open the clamping space by means of a screwdriver. To insert or remove the load, insert a screw driver at an angle as showed in **Figure 27** in order to open the clamp for inserting or releasing the cable.

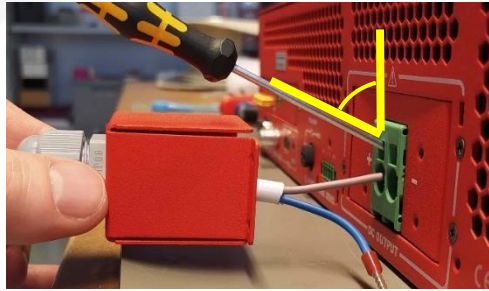

Figure 27: Insertion/Removal of the load cable from HV models by inserting the screwdriver at an angle.

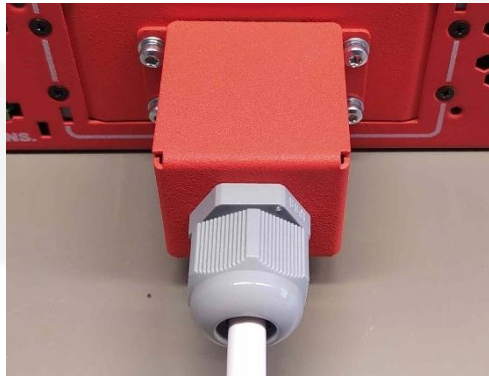

Figure 28: Output terminals of HV models with metallic cover and cable gland mounted.

Please remember to tighten the cable gland after securing the metal cover.

3.5 Front Panel Indicators

The BatReg² has four LED indicators on the front panel as shown in the following **Figure 29**.

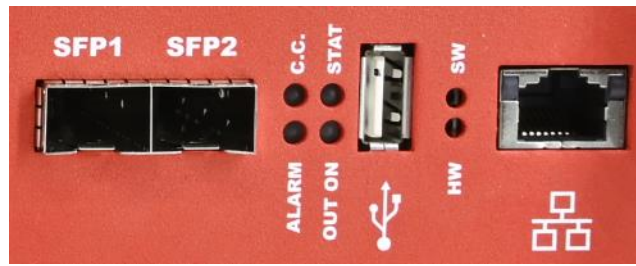

Figure 29: Front panel indicators

The front panel LED indicators and their behaviour are listed below (clockwise starting from top-left):

- **C.C.:** Constant Current mode (**blue**). When the LED is on, the BatReg² is operating in constant current mode. When the LED is off, it’s operating in Constant Voltage mode (C.V.);
- **STAT (green):** it signals the correct working-operation of the diagnostics module by blinking with 1-second period;
- **OUT ON (blue):** it signals that the output is enabled. The blue LED lights-up when the output is enabled regulating either in C.V. or C.C. modes;
- **ALARM (red):** if turned on, it signals that one or more fault conditions have occurred. When the fault condition/cause has been addressed, it is resetting the PS fault status register is mandatory, in order to enable the PS’ output again.

Additionally, the two push buttons indicated as “HW” and “SW” and the USB port are used for debugging purposes only, the User must not use them.

3.6 Internal Protections

The BatReg² is equipped with several internal protections (faults, see **Table 3.6**) that allow PS configuration for optimal operation. These protections avoid damages/undesired behaviour to/of both the PS and the connected load/device

Faults
Overtemperature
DC Link Fault
Input Overcurrent
Overpower
DCCT Error
Output Overcurrent
Output Overvoltage
Thermocouple Fault
Fans Error
Solid State Relay Fault

Table 3.6: List of internal protections (faults).

Internal protections are characterized by different configuration parameters which are stored in the PS’ Internal Memory, structured as follows:

ID	Name	Value	Privileges
----	------	-------	------------

- *ID*: memory address (not editable);
- *Name*: name of the variable (not editable);
- *Value*: variable value (editable);
- *Privileges*: variable privileges (not editable).

The internal protection parameters (variables) can be modified in two ways:

1. From the GUI (see the “*Quick Start Guide*” for more information);
2. With TCP/IP commands (see the “*Commands Reference Manual*” for more information).

In the following sections the full list of internal protections is addressed. A brief description of the internal protections is presented with some additional basic info on their operation and use. Additionally, for each internal protection the configuration parameters (variables) and the respective Internal Memory addresses are reported.

3.6.1 Overtemperature Fault

Internal monitoring of power stage temperature is performed. If the pre-defined threshold of 80 [°C] is exceeded for 1 [s] a fault condition is generated, which disables the PS' output. To reset the fault status register and to enable the PS output again, the temperature must be below the maximum threshold. The same fault condition is generated when the temperature sensor is disconnected.

3.6.2 DC-Link Fault

The BatReg² is composed by a bidirectional power AC-DC section, cascaded with a DC-DC stage. The DC voltage generated by the AC-DC section is named DC-Link and it is proportional to the model specific maximum rated voltage. Usually, the DC-Link voltage is higher than the rated output of the BatReg². Continuous monitoring of the DC-Link voltage is performed for obtaining the maximum voltage from the PS at all times. If the DC-Link voltage either drops below or becomes larger than a set threshold, the regulation capabilities of the PS could be compromised and a fault condition is generated. The over/under voltage fault is triggered by a hardware circuit and, as previously mentioned, the thresholds are set taking into account the model specific ratings. It is necessary to reset the status register and to resolve the fault's cause before turning the PS back on again.

3.6.3 Input OverCurrent – OVC

The internal current drawn from the AC/DC converter by the DC/DC power stages is sensed by a hall transducer. This current is compared with a threshold set in hardware. The threshold value for intervention depends on the BatReg² specific model and cannot be changed by the user. The tripping of this fault generates a latched fault condition that disables the output. A reset of the PS fault status register needs to be performed in order to enable the PS output again.

3.6.4 DCCT Error

The PS is continuously monitoring the status of the DCCT (output current transducer). If the DCCT malfunctions, the PS detects it and the output switched OFF to prevent inaccurate operation or potential damage. To resume normal operation the fault must be resolved before resetting the status register.

3.6.5 OverPower - OVP



The BatReg² can work continuously at a 2% over its power rating as expressed in the specifications, **either in source or sink operation**. The module is capable of operating at a power comprised between 2% and 5% over its rating – i.e. between 102% and 105% – for a 120-second period before turning off on an over-power fault. If the actual output power drawn from the PS is more than 5% above its nominal ratings the PS output is automatically disabled after 1 second. This behaviour is summarized in the following **Table 3.7** (an example of a BREG2010150A is also listed):

Output Power	Time of Operation
< 102% of $ P_N $ < 1530 W	Continuous
< 105% of $ P_N $ < 1575 W	120 s
$\geq 105\%$ of $ P_N $ ≥ 1575 W	1 s

Table 3.7: Over-power logic characteristics for a BatReg² 10 V 150 A.

where $|P_N|$ is the rated nominal output power (indicated as absolute value to indicate source and sink operation) of the PS, as indicated in the technical specifications.

3.6.6 Output Overcurrent/Overvoltage

The PS allows the user to set an output limit on the output current and/or voltage. If the limits are exceeded, the PS output is automatically switched OFF. The limits can be set either by the GUI or by TCP/IP commands (for the TCP/IP commands refer to the “*Commands Reference Manual*”).

Output Overcurrent/overvoltage settings are accessible in the Internal Memory (Internal Memory addresses are reported in **Table 3.8**).

ID	Name
100	Output Over-Current Limit [A]
101	Output Over-Voltage Limit [V]

Table 3.8: Output Overcurrent/overvoltage settings parameters in Internal Memory.

3.6.7 Thermocouple Fault

If the BatReg² is equipped with option FB1K5OPT001 it is possible to connect a K-type thermocouple and eventually enable the TC (ThermoCouple) fault condition.



The TC fault is triggered when the temperature goes out of User-defined min/max thresholds.

3.6.8 Fans Error

The PS constantly monitors the fans' status. If one or more fans are not working correctly the PS' output is automatically switched OFF. If this fault cannot be reset, even after a power-cycle, the PS has to be sent back for repair (see RMA procedure section). This protection ensures safe operation of the power supply.



4. Advanced Functions

4.1 Waveform

The BatReg² is able to act as a waveform generator both in C.C. and C.V. regulation modes. The waveform is stored internally in a file; the maximum number of waveform points and its sampling period (of the waveform execution) can be defined by the user, giving flexibility to the waveform generator applicability. The minimum time interval for the waveform execution period is limited to 0.01 ms = 10 μ s, resulting in an output waveform update rate of 100 kHz. In order to correctly execute the output waveform, it is necessary to properly tune the PS' PID regulator parameters for the specific load in use.

More information on the waveform feature can be found in the “*Quick Start Guide*” and in the “*Commands Reference Manual*”.

5. Mechanical Dimensions

The mechanical dimensions of the PS are hereafter presented:

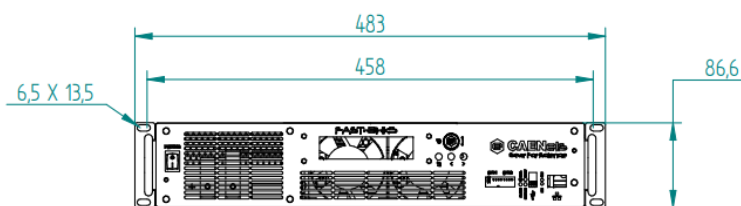

Figure 30: BatReg² Mechanical Drawings of the Front Panel.

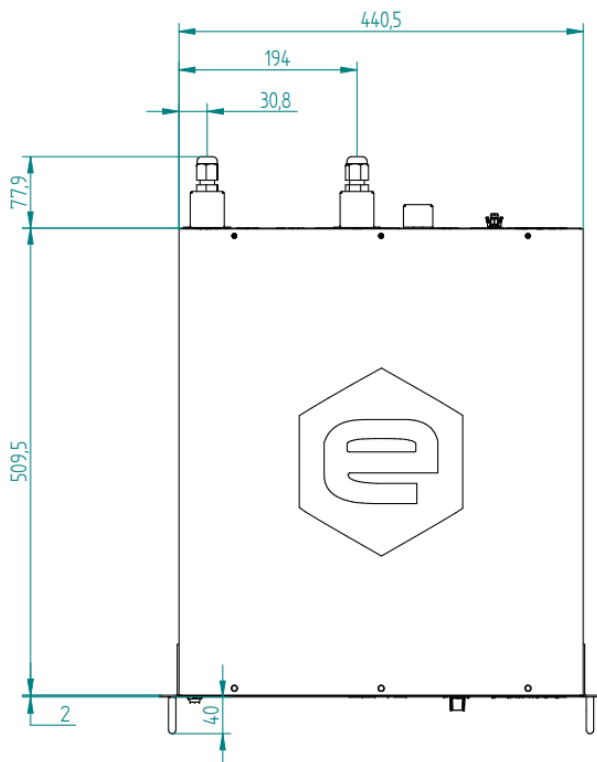

Figure 31: BatReg² Mechanical Drawings for the HV models.

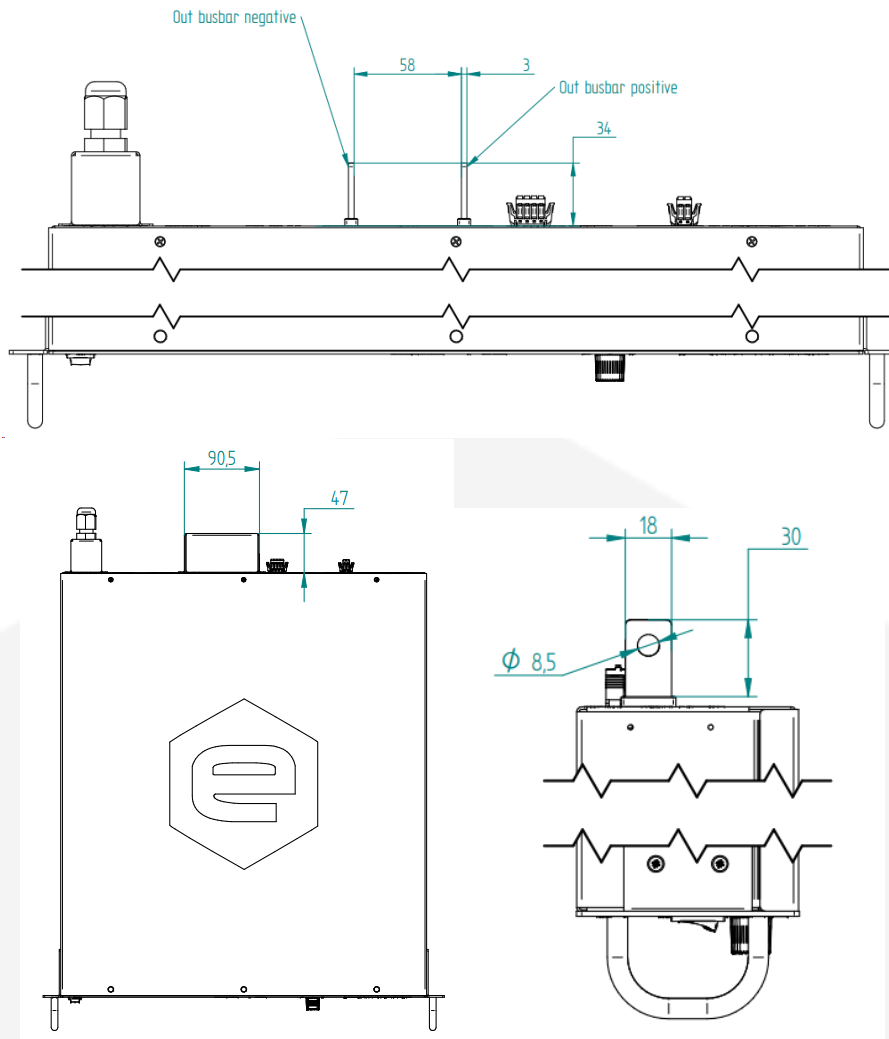

Figure 32: BatReg² Mechanical Drawings for the HC models.

6. Technical Specifications

The main technical specifications for the standard BatReg² HC models are hereafter presented:

Technical Specifications	BatReg ² HC Models		
	40-50	20-100	10-150
Output Voltage	0-40 V	0-20 V	0-10 V
Output Current	±50 A	±100 A	±150 A
Rated Output Power	1500 W		
Topology	Bidirectional and Regenerative		
Regulation Mode	Constant Current (C.C.) and Constant Voltage (C.V.)		
Remote Sensing	up to 0.5 V		
Current Sensing	Internal High-Precision Current Transducers		
Current Setting Resolution	24-bit		
Voltage Setting Resolution	24-bit		
Output Readback Resolution	24-bit		
Switching Frequency (equivalent)	200 kHz		
Efficiency AC/DC	> 86 %		> 80 %
Efficiency DC/AC	> 86 %		> 80 %
Output Accuracy RMS	< 0.01 %		
Temperature Stability	< 10 ppm/K/FS		
Long Term Stability (8 h)	< 10 ppm/FS		
Cooling	Forced air convection		
Analog Bandwidth (-3 dB)*	8 kHz	8 kHz	8 kHz
Rise time 10-90% *	< 50 μs	< 50 μs	< 50 μs
Control/Communication Interface	Ethernet 10/100/1000 Mbit TCP-IP or UDP SFP/SFP+		
Local Control	Color display with multi-function navigation switch Output Enable Button		

External Signals	4 x External Interlock Inputs (configurable dry contacts) 1 x Status Output Relay (magnetic) 1 x Output Relay (solid state)		
Optional Features (code FB1K5OPT0001)	1 x Trigger Input (LVTTTL, TTL) 1 x Analog Control Input (± 10 V) 1 x Auxiliary ADC Input (16 bit, 100 ksps) 1 x K-type Thermocouple Input		
Extra Features	Waveform execution Remote Firmware Update Linux OS on-board Configurable Acoustic Alarm		
Auxiliary Readbacks	DC-Link Voltage Temperature		
Hardware Protections	Input Fuses Battery Polarity Detection Circuit		
Mechanical Dimensions (LxWxH)	19" x 2U x 587 mm (including connectors)		
Input Ratings	180 - 264 VAC / 47 - 63 Hz		
Weight (typ.)	15 kg	15 kg	15 kg
Operating Ambient Temperature	0 ... 40 °C		
Audible Noise Level (No Load / 50% Load / 80% Load / 100% Load)	47 dB / 53 dB / 61 dB / 67 dB		

Table 6.1: BatReg² HC models technical specifications.

The main technical specifications for the standard BatReg² HV models are hereafter presented:

Technical Specifications	BatReg ² HV Models	
	100-20	50-30
Output Voltage	0-100 V	0-50 V
Output Current	±20 A	±30 A
Rated Output Power	1500 W	
Topology	Bidirectional and Regenerative	
Regulation Mode	Constant Current (C.C.) and Constant Voltage (C.V.)	
Remote Sensing	up to 0.5 V	
Current Sensing	Internal High-Precision Current Transducers	
Current Setting Resolution	24-bit	
Voltage Setting Resolution	24-bit	
Output Readback Resolution	24-bit	
Switching Frequency (equivalent)	200 kHz	
Efficiency AC/DC	> 86 %	> 80 %
Efficiency DC/AC	> 86 %	> 80 %
Output Accuracy RMS	< 0.01 %	
Temperature Stability	< 10 ppm/K/FS	
Long Term Stability (8 h)	< 10 ppm/FS	
Cooling	Forced air convection	
Analog Bandwidth (-3 dB)*	6.5 kHz	
Rise time 10-90%*	< 65 µs	
Control/Communication Interface	Ethernet 10/100/1000 Mbit TCP-IP or UDP SFP/SFP+	
Local Control	Color display with multi-function navigation switch Output Enable Button	
External Signals	4 x External Interlock Inputs (configurable dry contacts) 1 x Status Output Relay (magnetic) 1 x Output Relay (solid state)	
Optional Features (code FB1K5OPT0001)	1 x Trigger Input (LVTTTL, TTL) 1 x Analog Control Input (±10 V) 1 x Auxiliary ADC Input (16 bit, 100 kps) 1 x K-type Thermocouple Input	
Extra Features	Waveform execution Remote Firmware Update Linux OS on-board	

	Configurable Acoustic Alarm	
Auxiliary Readbacks	DC-Link Voltage Temperature	
Hardware Protections	Input Fuses Battery Polarity Detection Circuit	
Mechanical Dimensions (L×W×H)	19" x 2U x 587 mm (including connectors)	
Input Ratings	180 - 264 VAC / 47 - 63 Hz	
Weight (typ.)	17 kg	15 kg
Operating Ambient Temperature	0 ... 40 °C	
Audible Noise Level (No Load / 50% Load / 80% Load / 100% Load)	47 dB / 53 dB / 61 dB / 67 dB	

Table 6.2: BatReg² HV models technical specifications.

* Provisional data, pending completion of tests.